



■ Vers. 450+275+269



■ Vers. 450+275+269



■ Vers. 450+275+338+275+452



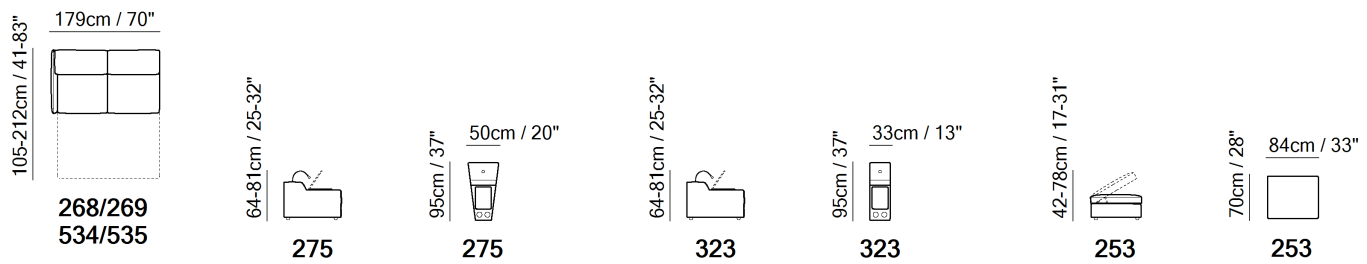
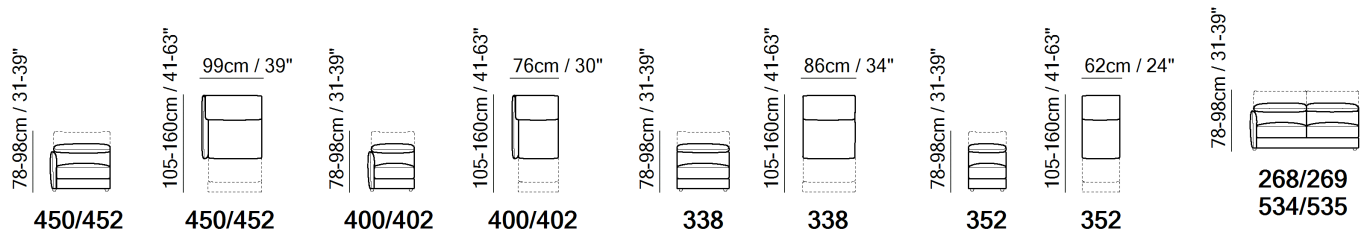
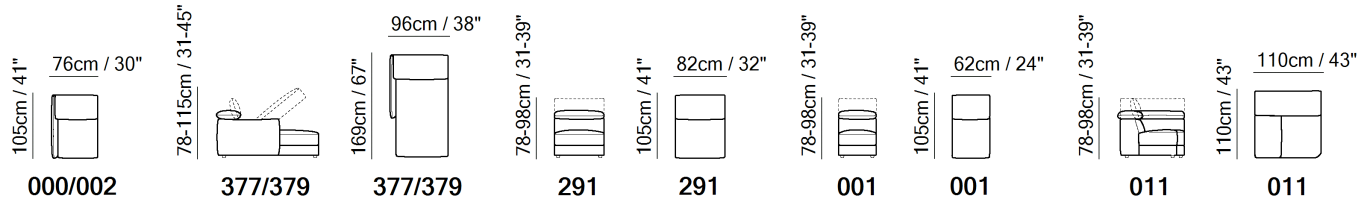
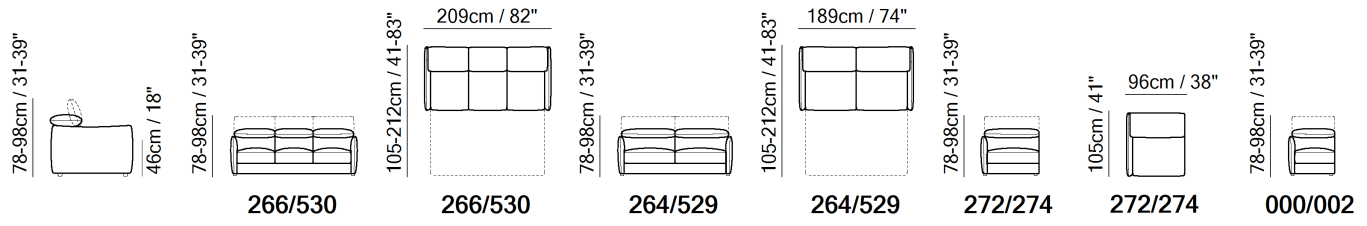

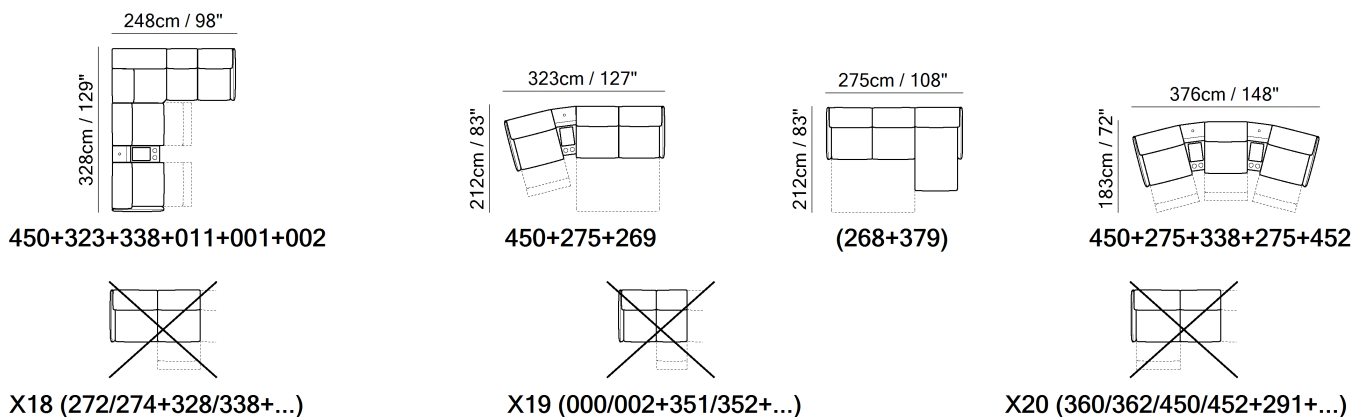

SCHEMATICS



COMPOSITION EXAMPLES



TECHNICAL INFORMATION

	COVERING	Leather <input checked="" type="checkbox"/>	Soft Cover <input checked="" type="checkbox"/>			
	FILLING	Arms <input type="checkbox"/> Fiber <input checked="" type="checkbox"/> Foam <input type="checkbox"/> Feather/Fiber Mix <input type="checkbox"/> Feather	Seat cushion <input type="checkbox"/> Fiber <input checked="" type="checkbox"/> Foam <input type="checkbox"/> Feather/Fiber Mix <input type="checkbox"/> Feather	Back cushion <input type="checkbox"/> Fiber <input checked="" type="checkbox"/> Foam <input type="checkbox"/> Feather/Fiber Mix <input type="checkbox"/> Feather		
	COMFORT	Standard Comfort <input checked="" type="checkbox"/>	Firm Comfort <input type="checkbox"/>			
	FUNCTION	Bed <input checked="" type="checkbox"/>	Electric motion <input checked="" type="checkbox"/>	Motion <input checked="" type="checkbox"/>	Recliner <input type="checkbox"/>	Sliding <input type="checkbox"/>
	VISUAL APPEARANCE*	Low <input checked="" type="checkbox"/>	Medium <input type="checkbox"/>	High <input type="checkbox"/>		
	LEGS	Wood <input type="checkbox"/>	Metal <input type="checkbox"/>	Plastic <input checked="" type="checkbox"/>	Castors <input type="checkbox"/>	Upholstered <input type="checkbox"/>

VISUAL APPEARANCE

The product may reveal various wrinkles due to the combination of Elasticity of the covering, characteristics of the interior construction and the design of the product.



Products with Visual Appearance listed as High or Medium would require higher degree of care, where seats and back cushions may require fluffing and plumping more often than Products with Visual Appearance listed as Low.

BED MECHANISM & MATTRESS

MECHANISM		MATTRESS		
VERSIONS	TYPE	VERSIONS	TYPE	DIMENSIONS
268,269,534,535	Ready-Bed electro-welded - Double folding	264,268,269	GREENPLUS	W L H 140 195 11
264,529	Ready-Bed electro-welded - Double folding	529,534,535	Memory	140 195 11
266,530	Ready-Bed electro-welded - Double folding	266	GREENPLUS	160 195 11
		530	Memory	160 195 11

Ready-Bed electro-welded The back cushion goes under the bed mechanism.
GREENPLUS GREENPLUS mattress is a patented, innovative product. It is ecological, made up of microporous elastomers. It has a great adaptation capacity to the various body pressure which gives big support to the spine. It is antibacterial and no-allergic.
Memory Non-allergic memory mattress available with zippered cover that can be easily taken off and washed.

NOTES

- Available in leather or fabric.
- Model is available with contrast welt (or any another decorative detail such as a band under arm cushion) to be entered as second covering in the same category.
- FABRIC: In fabric contrast welt (or any another decorative detail such as a band under arm cushion) can be made either in same category fabric or in leather with any color of Le Mans (only).
- single power mechanism with internal switch on the seat cushion side that activates the recliner while the headrest is manually adjustable.
- Stationary versions have manually adjustable headrests.

NOTES

- A battery pack can be ordered with its own version code 830. For order entry please use XX for category and XXX for cover code. In order to optimize the duration of the battery, it is suggested to order one per each motion seat.
- Tight Seat Cushion (the seat cushions of the models are fixed to the frame)
- Tight Back Cushion (the back cushions of the models are fixed to the frame)
- No Leather Side (the sectional pieces have the side covered with lining and not leather)
- Internal wooden frame.
- Feet requires assembling. Feet will be in a bag inside the package.
- Packaging: Cardboard wrap.
- Feet height 3,5 cm